

Rebuild  
the  
world



11013

60281

2x 6284599	2x 366024	1x 6324143	4x 6240550	2x 6020074
1x 4143005	1x 300124	1x 379528	1x 6314353	1x 6097509
1x 6168644	1x 6172383	2x 4616279	6x 6219825	1x 6097509
1x 370024	1x 6097283	1x 4153825	1x 6122504	1x 6313188
1x 6313592			1x 6028736	1x 4211429

1

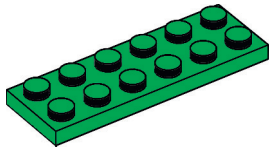

2

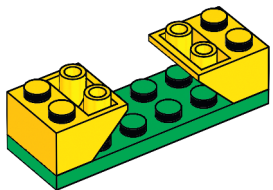

3

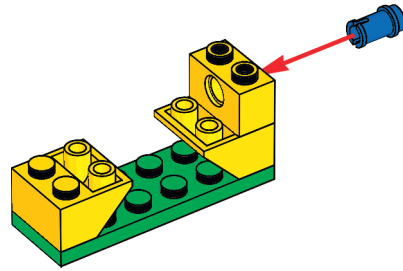

4

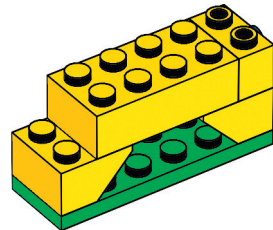

5

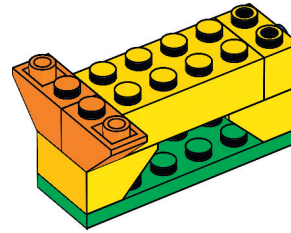

6

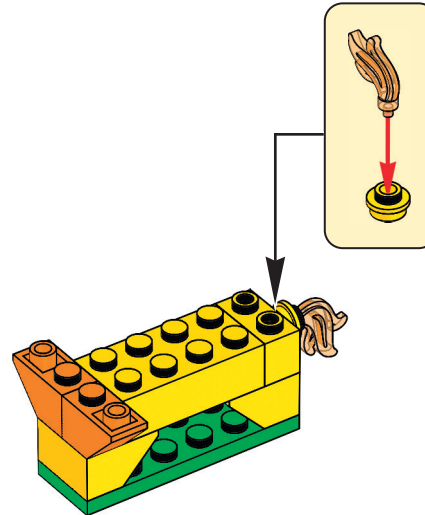

7

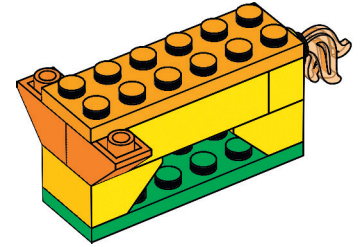

8

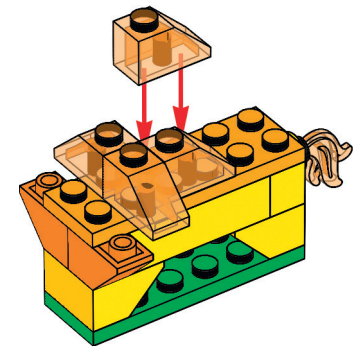

9

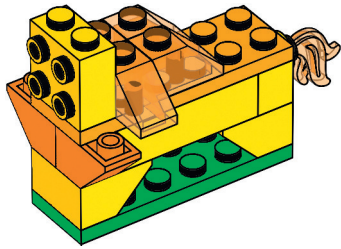

10

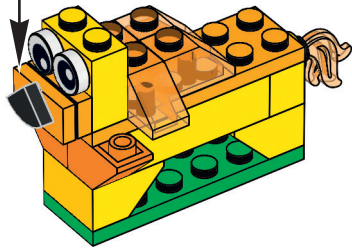
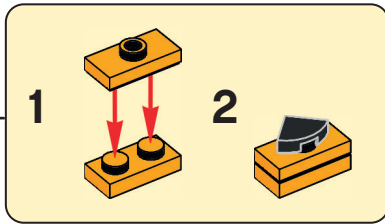

11

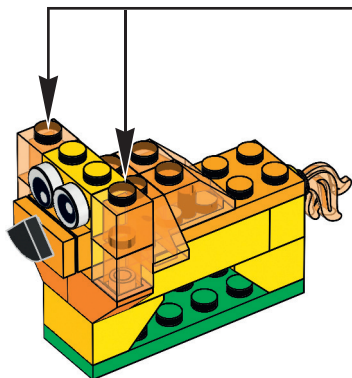
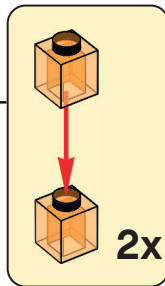

12

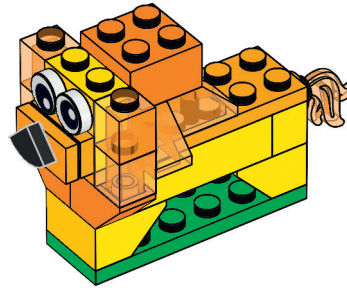

13

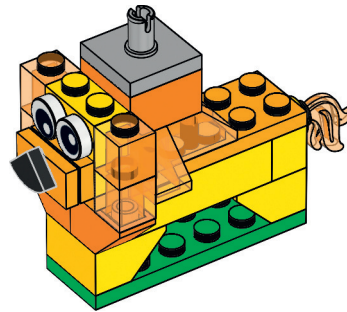

14

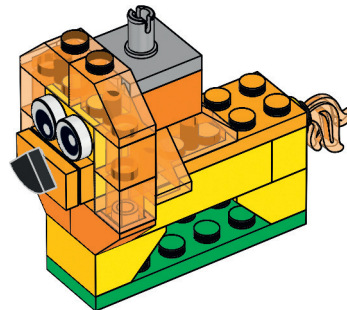

15

